

SIRUBA®

銀箭牌工業用縫紉機
INDUSTRIAL SEWING MACHINE

R718 WITH TRIMMER







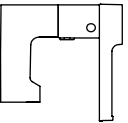
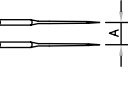
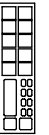
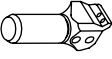

R728 WITH TRIMMER

零件圖 PARTS LIST



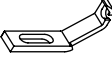

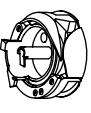





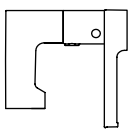

CE

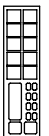
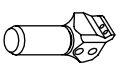
 高林股份有限公司
KAULIN MFG. CO., LTD.

											
MODEL	NEEDLE GAUGE SIZE	OPERATING PANEL	NEEDLE CLAMP	NEEDLE PLATE	PRESSER FOOT	ROLLER HOLDER BRACKET	NEEDLE GUARD	NEEDLE	HOOK ASM	BOBBIN CAP	BOBBIN
機 型	針 幅	操 作 盒	針 座	針 板	輪 線 組	滾 輪 支 座	頂 針 片	針 號	梭 頭	梭 帽	梭 子
R718-01-00											
R718-01-02											
R718-01-04				E700Q	中	RE23P-A					
R718-01-05						中					
R718-01-10		C300M-A1									
R718-01-12											
R718-01A-00											
R718-01A-02											
R718-01A-04				E700Q	小	RE23-A			G155	G403	G305
R718-01A-05								DP*5#16			
R718-01A-10		C300M-A1									
R718-01A-12											
R718-01B-00											
R718-01B-02											
R718-01B-04				E700Q	大	RE23Q-A					
R718-01B-05											
R718-01B-10		C300M-A1									
R718-01B-12											

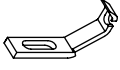

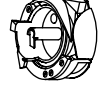



規格件表 CONVERSION CHART-2

MODEL	NEEDLE GAUGE SIZE	OPERATING PANEL	NEEDLE CLAMP	NEEDLE PLATE	PRESSER FOOT ASM	ROLLER HOLDER BRACKET	NEEDLE GUARD	NEEDLE	HOOK ASM	BOBBIN CAP	BOBBIN
機 型	針 幅	操 作 盒	針 座	針 板	輪 錢 組	滾 輪 支 座	頂 針 片	針 號	梭 頭	梭 帽	梭 子
R718-02-00	—	—	—	E710Q	中 RE23P-A	中 RE36	—	DP*5#16	G155	G403	G305
R718-02-02											
R718-02-02E											
R718-02-04											
R718-02-05											
R718-02-05E											
R718-02-10											
R718-02-12											
R718-02-12E											
R718-02A-00											
R718-02A-02											
R718-02A-02E											
R718-02A-04											
R718-02A-05											
R718-02A-05E											
R718-02A-10											
R718-02A-12											
R718-02A-12E											
R718-02B-00	—	—	—	E710Q	大 RE23Q-A	大 RE29	—	—	G155	G403	G305
R718-02B-02											
R718-02B-02E											
R718-02B-04											
R718-02B-05											
R718-02B-05E											
R718-02B-10											
R718-02B-12											
R718-02B-12E											

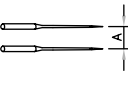
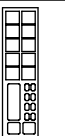
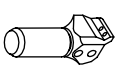
 MODEL 機 型	 NEEDLE GAUGE SIZE 針 幅	 OPERATING PANEL 操 作 盒	 NEEDLE CLAMP 針 座	 NEEDLE PLATE 針 板	 PRESSER FOOT ASM 輪 錢 組	 ROLLER HOLDER BRACKET 滾 輪 支 座	 NEEDLE GUARD 頂 針 片	 NEEDLE 針 號	 HOOK ASM 梭 頭	 BOBBIN CAP 梭 帽	 BOBBIN 梭 子
R728-16-00	1.6	—	M728	E716Q	中	RE23P-A	RE36	DP*5#16	G155	G403	G305
R728-16-02											
R728-16-02E											
R728-16-04											
R728-16-05											
R728-16-05E	C300M-A1										
R728-16-10	1.6	—	M728	E716Q	小	RE23-A	RE27	RF31S	G155	G403	G305
R728-16-12											
R728-16-12E											
R728-16A-00											
R728-16A-02											
R728-16A-02E	C300M-A1										
R728-16A-04	1.6	—	M728	E716Q	大	RE23Q-A	RE29	RF31S	G155	G403	G305
R728-16A-05											
R728-16A-05E											
R728-16A-10											
R728-16A-12											
R728-16A-12E	C300M-A1										
R728-16B-00	1.6	—	M728	E716Q	大	RE23Q-A	RE29	RF31S	G155	G403	G305
R728-16B-02											
R728-16B-02E											
R728-16B-04											
R728-16B-05											
R728-16B-05E	C300M-A1										
R728-16B-10	1.6	—	M728	E716Q	大	RE23Q-A	RE29	RF31S	G155	G403	G305
R728-16B-12											
R728-16B-12E											

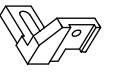
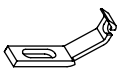
規格件表 CONVERSION CHART-4

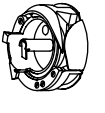
MODEL	NEEDLE GAUGE SIZE	OPERATING PANEL	NEEDLE CLAMP	NEEDLE PLATE	PRESSER FOOT ASM	ROLLER HOLDER BRACKET	NEEDLE GUARD	NEEDLE	HOOK ASM	BOBBIN CAP	BOBBIN
機 型	針 幅	操作盒	針 座	針 板	輪 錢 組	滾 輪 支 座	頂 針 片	針 號	梭 頭	梭 帽	梭 子
R728-20-00	2.0	—	M728	E720Q	中	RE23P-A	RE36	DP*5#16	G155	G403	G305
R728-20-02											
R728-20-02E											
R728-20-04											
R728-20-05											
R728-20-05E											
R728-20-10	C300M-A1	—	M728	E720Q	小	RE23-A	RE27	RF31Q	G155	G403	G305
R728-20-12											
R728-20-12E											
R728-20A-00	2.0	—	M728	E720Q	大	RE23Q-A	RE29	RF31Q	G155	G403	G305
R728-20A-02											
R728-20A-02E											
R728-20A-04											
R728-20A-05											
R728-20A-05E											
R728-20A-10	C300M-A1	—	M728	E720Q	大	RE23Q-A	RE29	RF31Q	G155	G403	G305
R728-20A-12											
R728-20A-12E											
R728-20B-00	2.0	—	M728	E720Q	大	RE23Q-A	RE29	RF31Q	G155	G403	G305
R728-20B-02											
R728-20B-02E											
R728-20B-04											
R728-20B-05											
R728-20B-05E											
R728-20B-10	C300M-A1	—	M728	E720Q	大	RE23Q-A	RE29	RF31Q	G155	G403	G305
R728-20B-12											
R728-20B-12E											

MODEL												
機 型	NEEDLE GAUGE SIZE 針 幅	OPERATING PANEL 操作盒	NEEDLE CLAMP 針 座	NEEDLE PLATE 針 板	PRESSER FOOT ASM 輪 線 組	ROLLER HOLDER BRACKET 滾 輪 支 座	NEEDLE GUARD 頂 針 片	NEEDLE 針 號	HOOK ASM 梭 頭	BOBBIN CAP 梭 帽	BOBBIN 梭 子	
R728-24-00	2.4	—	M728	E724Q	中 RE23P-A	RE36		DP*5#16	G155	G403	G305	
R728-24-02												
R728-24-02E												
R728-24-04												
R728-24-05												
R728-24-05E	C300M-A1											
R728-24-10	2.4	—	M728	E724Q	小 RE23-A	RE27		DP*5#16	G155	G403	G305	
R728-24-12												
R728-24-12E												C300M-A1
R728-24A-00												
R728-24A-02												
R728-24A-02E	C300M-A1											
R728-24A-04	2.4	—	M728	E724Q	大 RE23Q-A	RE29		DP*5#16	G155	G403	G305	
R728-24A-05												
R728-24A-05E												C300M-A1
R728-24A-10												
R728-24A-12												
R728-24A-12E	C300M-A1											
R728-24B-00	2.4	—	M728	E724Q	大 RE23Q-A	RE29		DP*5#16	G155	G403	G305	
R728-24B-02												
R728-24B-02E												
R728-24B-04												
R728-24B-05												
R728-24B-05E	C300M-A1											
R728-24B-10	2.4	—	M728	E724Q	大 RE23Q-A	RE29		DP*5#16	G155	G403	G305	
R728-24B-12												
R728-24B-12E												C300M-A1

規格件表 CONVERSION CHART-5

規格件表 CONVERSION CHART-6

MODEL 機 型	NEEDLE GAUGE SIZE 針 幅	OPERATING PANEL 操作盒	NEEDLE CLAMP 針 座	NEEDLE PLATE 針 板	PRESSER FOOT ASM 輪線組	ROLLER HOLDER BRACKET 滾輪支座	NEEDLE 針 號	HOOK ASM 梭 頭	BOBBIN CAP 梭 帽	BOBBIN 梭 子
R728-224-00	2.4	—	M728	E724T	中 RE23P-A	中 RE36	DP*5#16	G155	G403	G305
R728-224-02										
R728-224-02E										
R728-224-04										
R728-224-05										
R728-224-05E										
R728-224-10	2.4	C300M-A1	M728	E724T	小 RE23-A	小 RE27	DP*5#16	G155	G403	G305
R728-224-12										
R728-224-12E										
R728-224A-00										
R728-224A-02										
R728-224A-02E										
R728-224A-04	2.4	—	M728	E724T	大 RE23Q-A	大 RE29	DP*5#16	G155	G403	G305
R728-224A-05										
R728-224A-05E										
R728-224A-10										
R728-224A-12										
R728-224A-12E										
R728-224B-00	2.4	C300M-A1	M728	E724T	大 RE23Q-A	大 RE29	DP*5#16	G155	G403	G305
R728-224B-02										
R728-224B-02E										
R728-224B-04										
R728-224B-05										
R728-224B-05E										
R728-224B-10	2.4	—	M728	E724T	大 RE23Q-A	大 RE29	DP*5#16	G155	G403	G305
R728-224B-12										
R728-224B-12E										

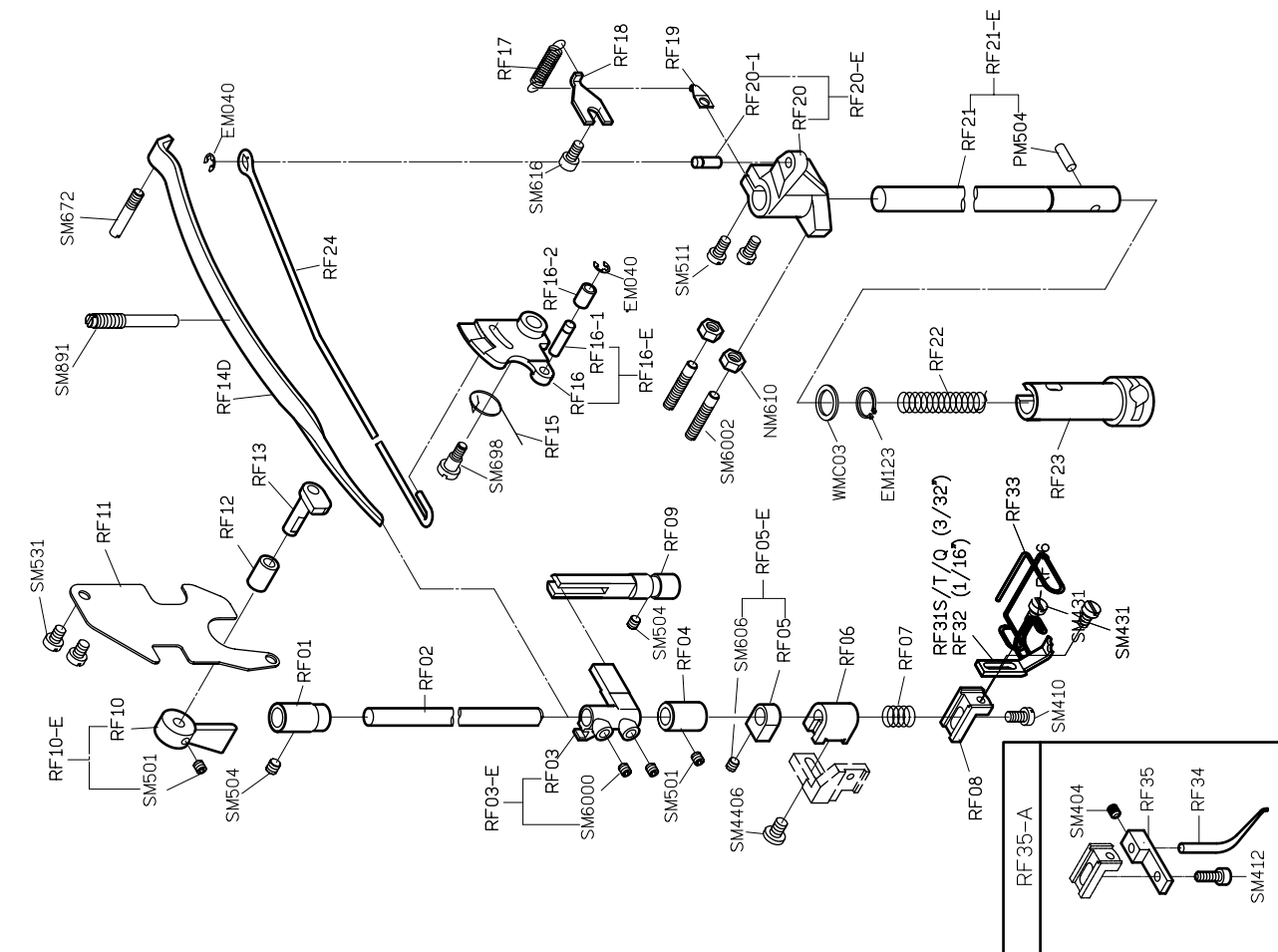
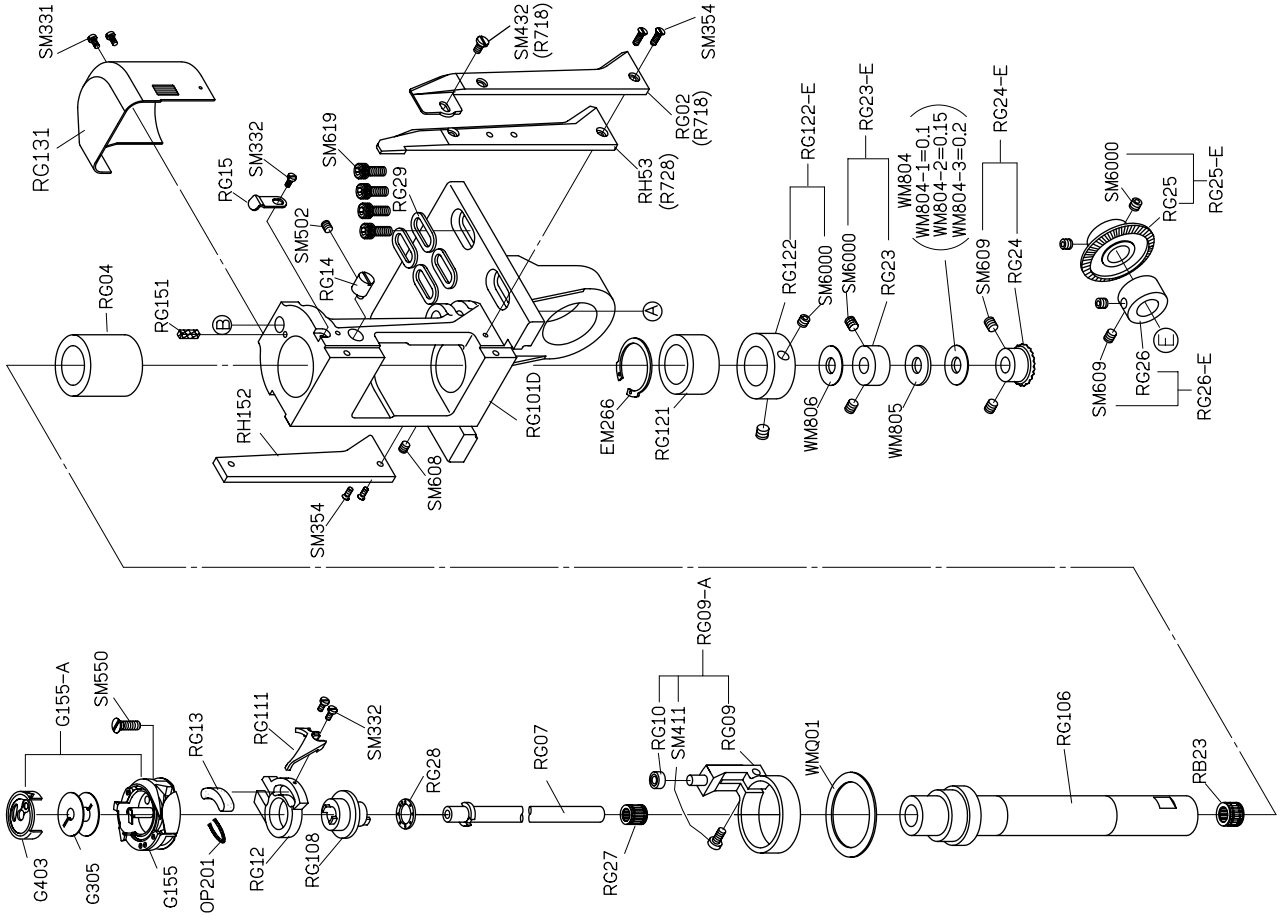

PARTS LIST FOR RG GROUP

PARTS LIST FOR RF GROUP

PARTS LIST FOR RH GROUP

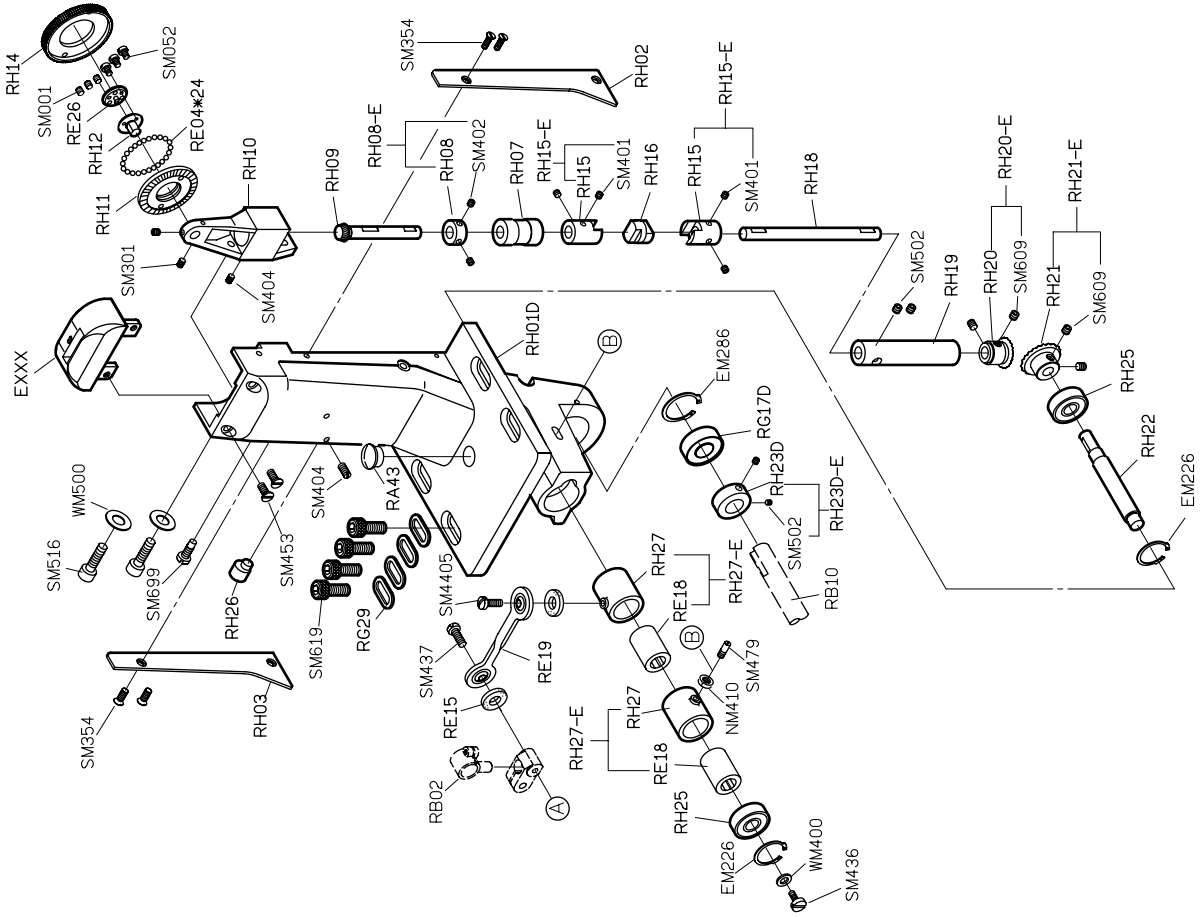

PARTS LIST FOR RH GROUP

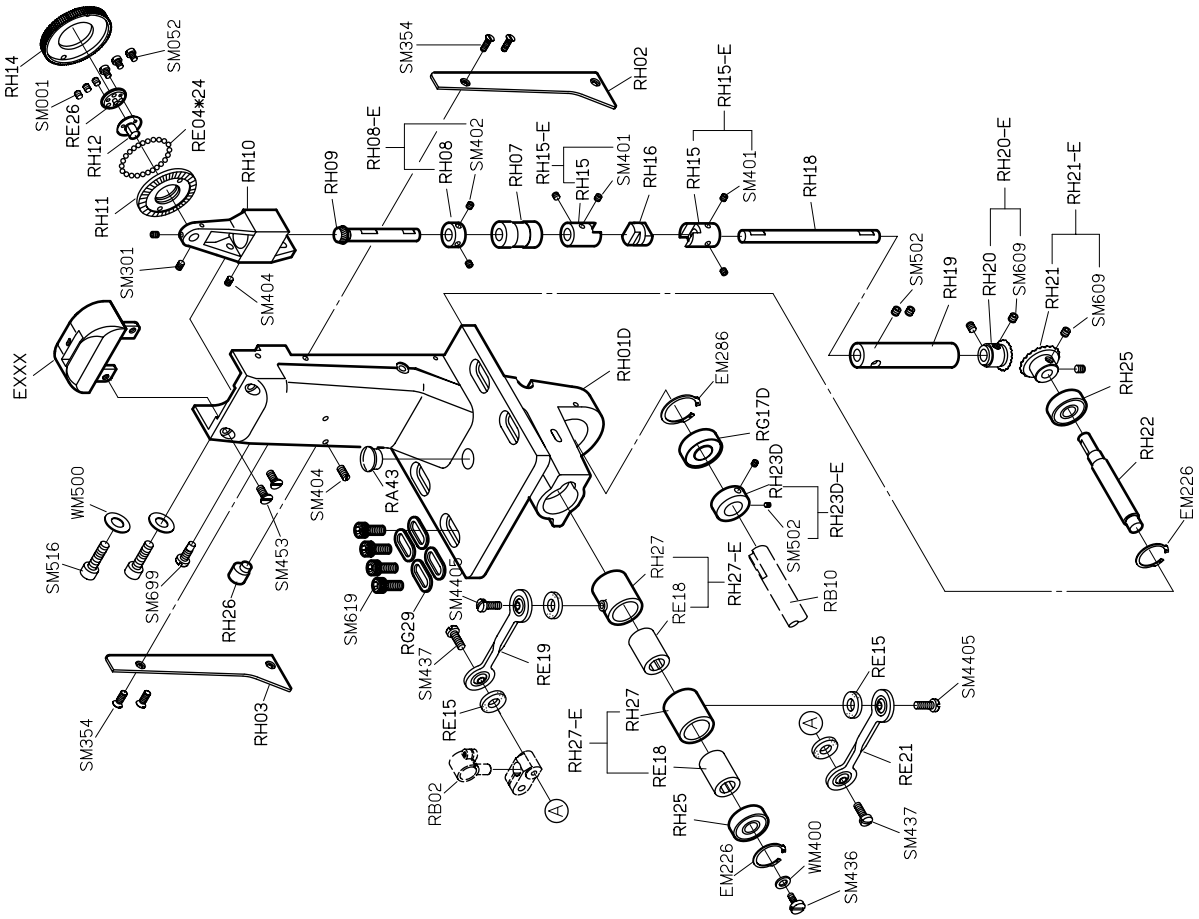

RJ01-A

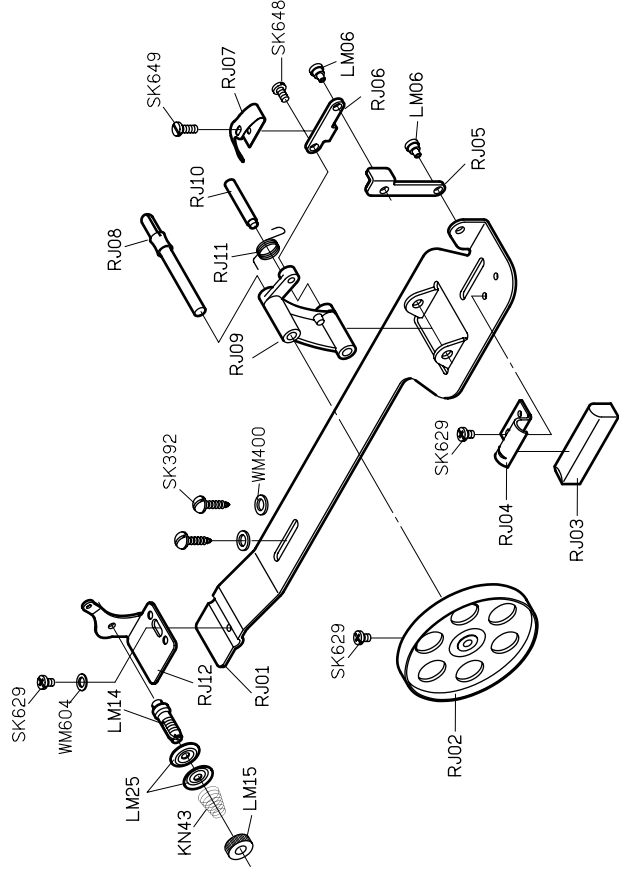

RM11-A

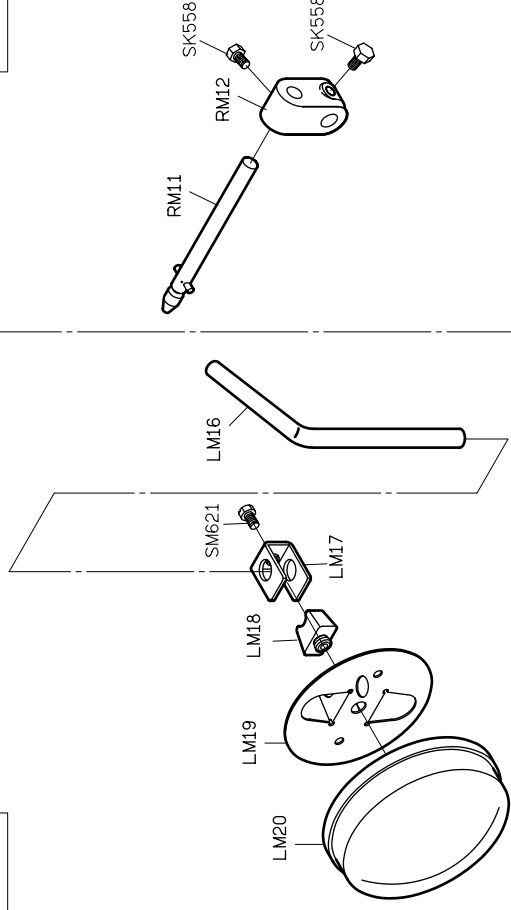

LM20-A

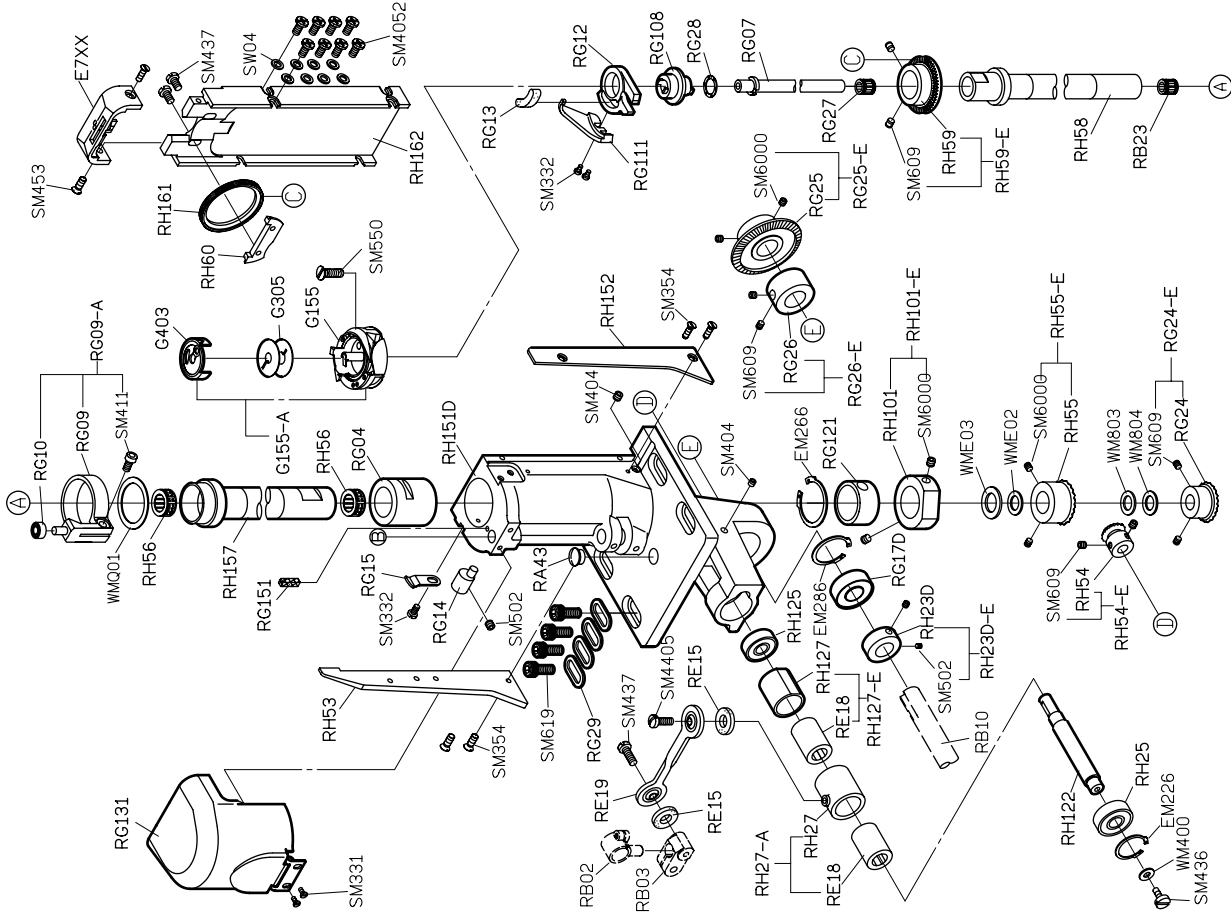

PARTS LIST FOR RH GROUP

PARTS LIST FOR RJ GROUP

RM22
(選附件)

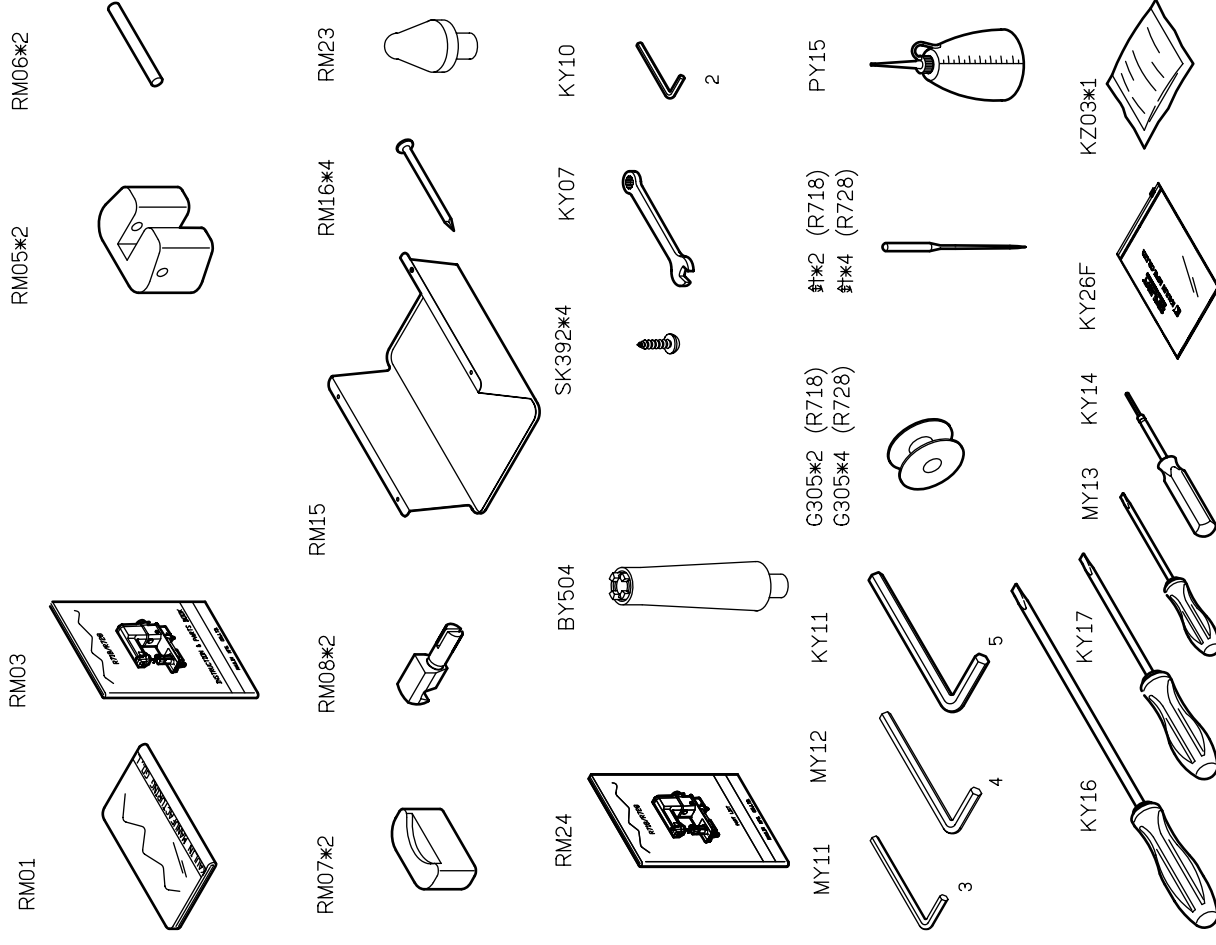
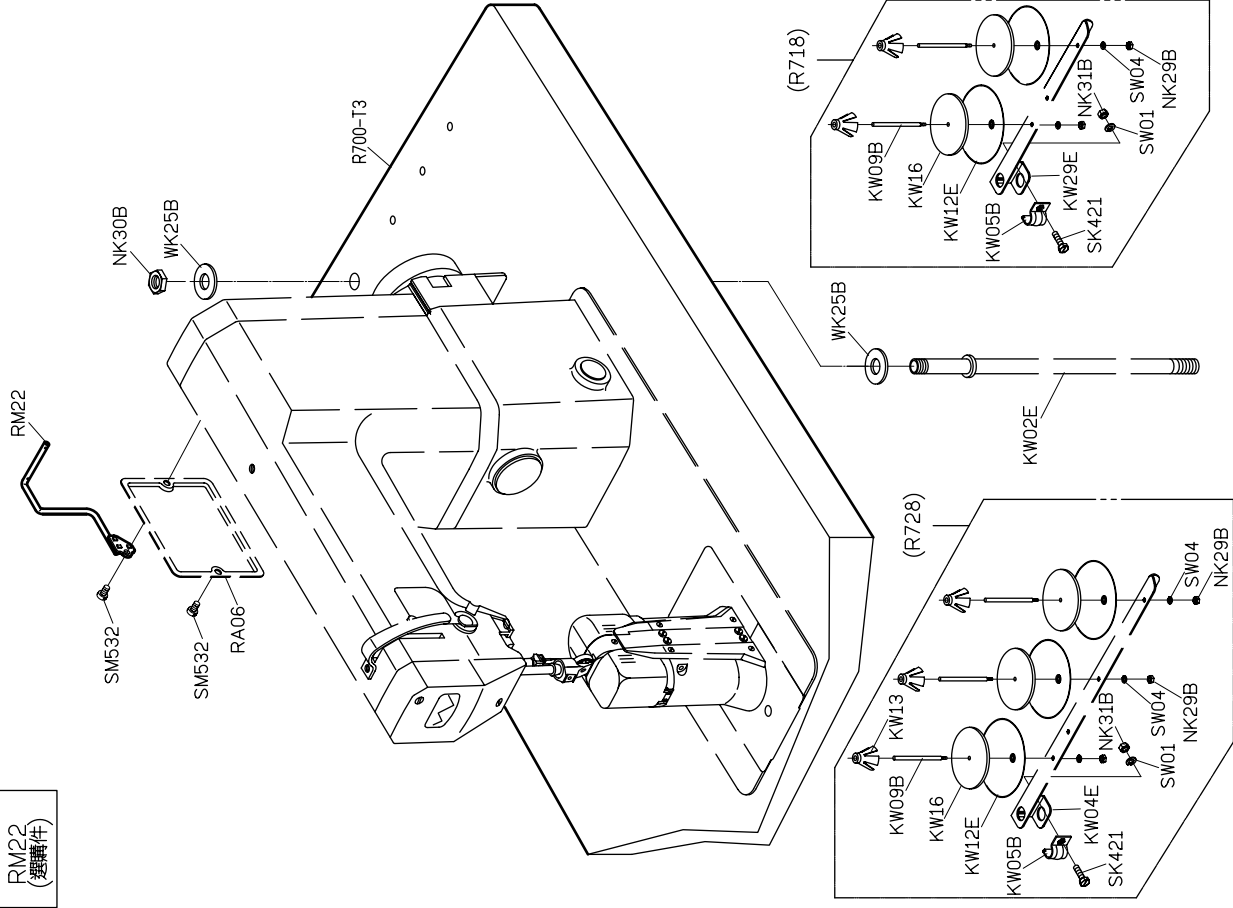

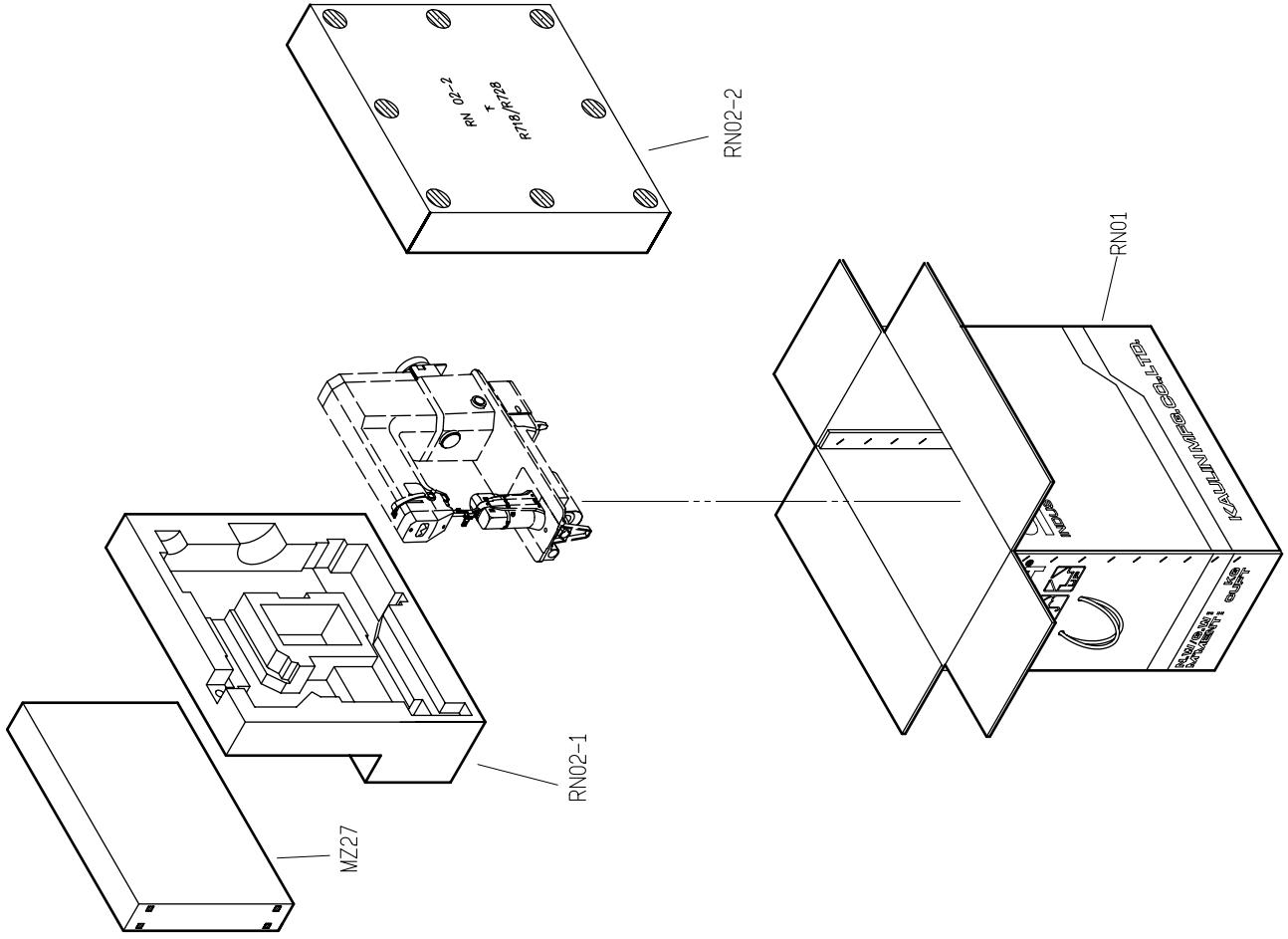

PARTS LIST FOR RN GROUP

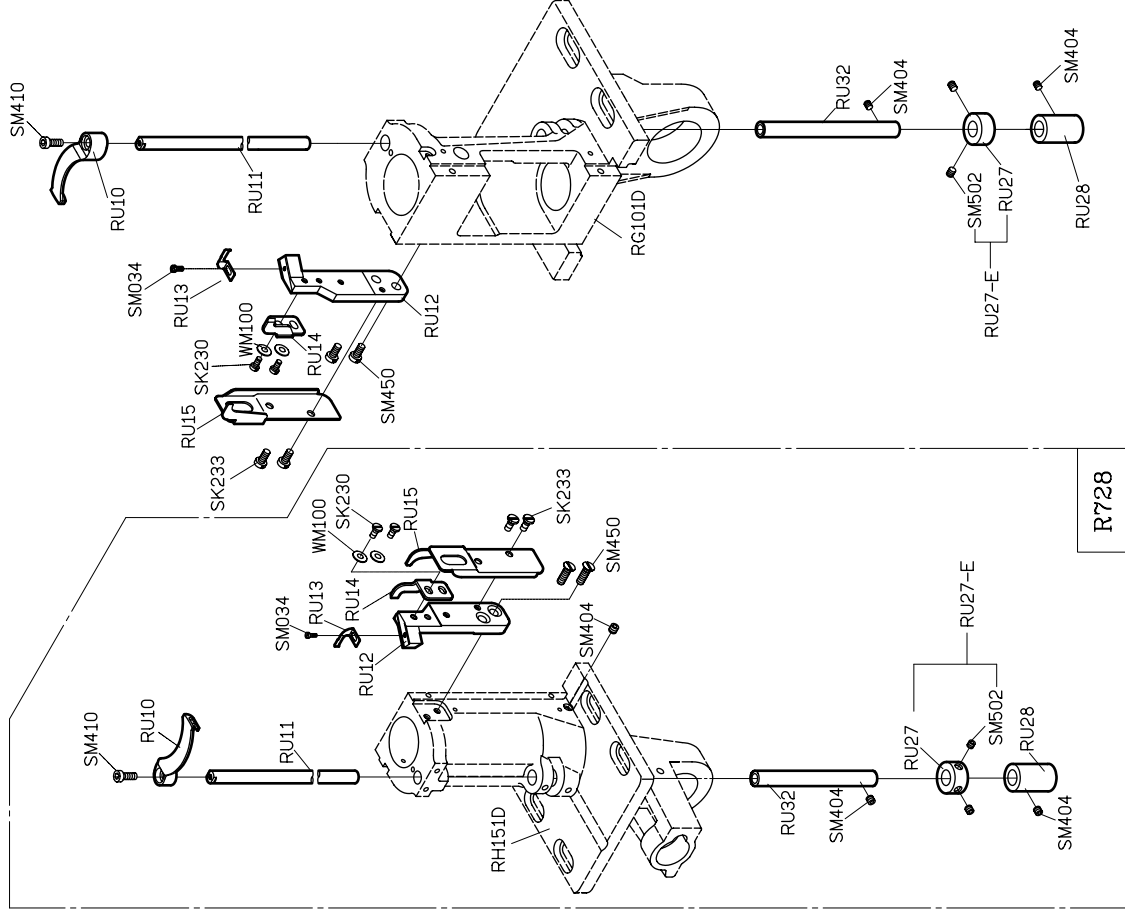

PARTS LIST FOR RU GROUP

PY11-3

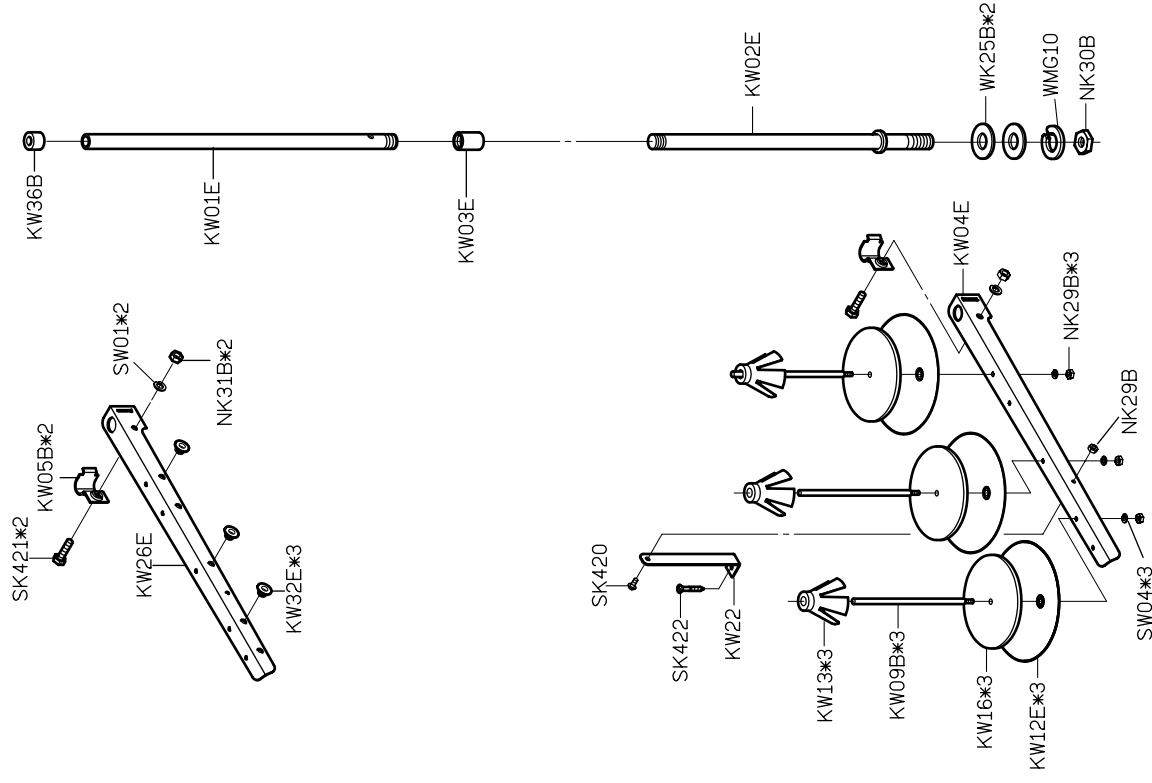
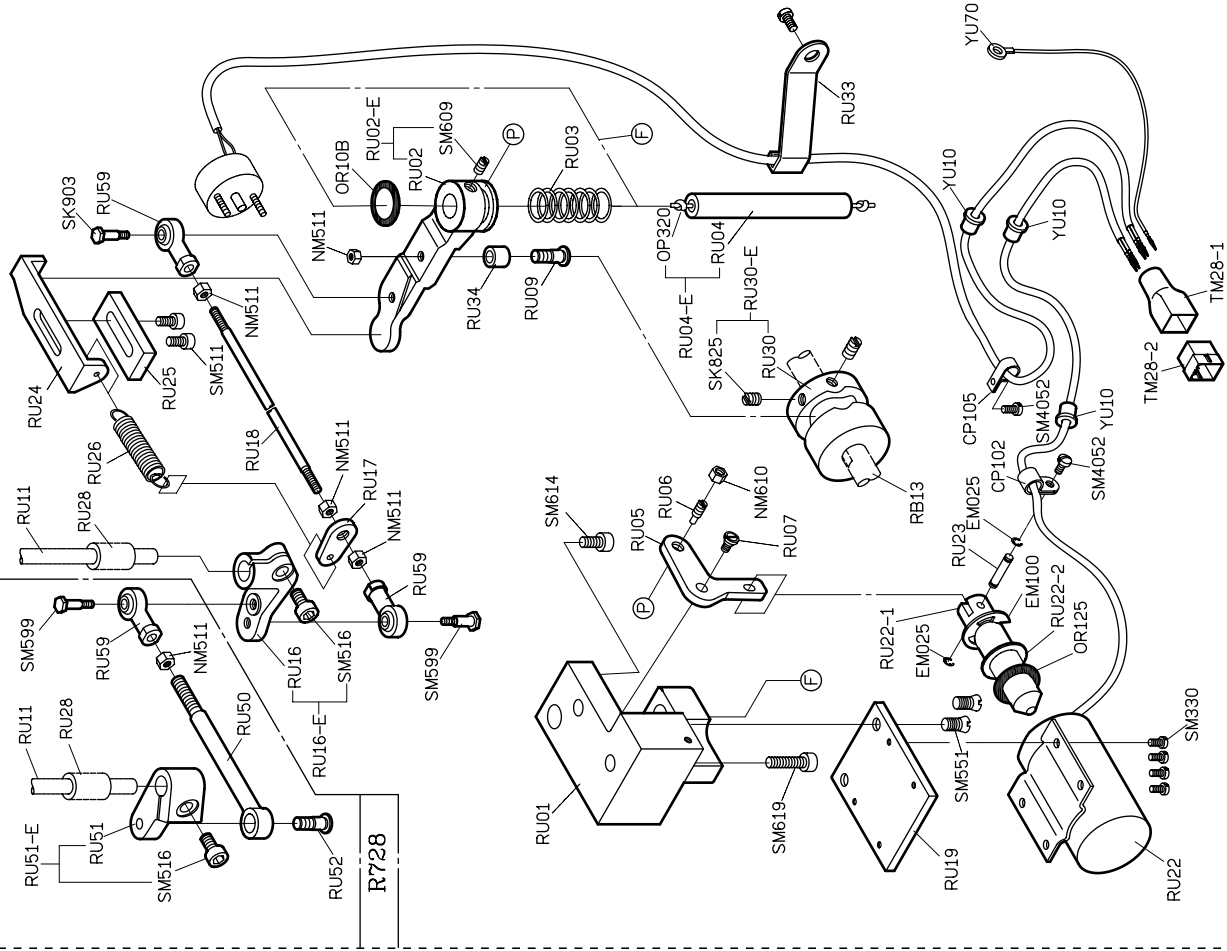



R718 WITH
TRIMMER

R728 WITH
TRIMMER

高林股份有限公司 KAULIN MFG. CO., LTD.